



LabelLase® 1000 Tag Printer
Service Manual

This manual is intended for qualified service technicians only.



Revision H
February 2016

INFOSIGHT CORPORATION

20700 U.S. Highway 23

P.O. Box 5000

Chillicothe, Ohio 45601 USA

+1.740.642.3600 Tel. (M-F 8am-5pm US Eastern Time Zone)

+1-800.401.0716 Emergency Service U.S. & Canada (outside normal business hours)

+1.740.642.4666 Emergency Service International (outside normal business hours)

+1.740.642-5001 Fax.

www.infosight.com

This page intentionally left blank.

COPYRIGHT

Copyright © 2003-20016 INFOSIGHT CORPORATION
All rights reserved, Printed in U.S.A.

First Printing: August 2003

INFOSIGHT CORPORATION reserves the right to make changes in specifications and other information contained in this manual without prior notice, and the reader should consult INFOSIGHT CORPORATION to determine whether any such changes have been made.

In no event shall INFOSIGHT CORPORATION be liable for any incidental, indirect, special, or consequential damages whatsoever (including but not limited to lost profits) arising out of, or relating to this manual or the information contained in it, even if INFOSIGHT CORPORATION has been advised, knew, or should have known of the possibility of such damages.



INFOSIGHT CORPORATION expressly warrants the equipment manufactured by it as set forth in the Standard Terms and Conditions of Sale. INFOSIGHT CORPORATION makes no other warranties, either expressed or implied (including without limitation warranties as to merchant ability or fitness for a particular purpose).

InfoTag[®], LabeLase[®], PermaLabel[®], Pic-Anneal[®], and Kettle Tag[®] Plus are registered trademarks of InfoSight Corporation.



LabeLase[®] Producer[™], Info-Tint[™], Foam Tag[™], Tough Tag[™], AlumaTag[™], and X-Tag[™] are trademarks of InfoSight Corporation.

Windows[®] is a registered trademark of Microsoft Corporation.

Optical/Laser Safety

	<p>INVISIBLE LASER RADIATION AVOID EYE OR SKIN EXPOSURE TO DIRECT OR SCATTERED RADIATION CLASS 1 LASER PRODUCT, USING A CLASS 4 EMBEDDED LASER (5 W, 10.57 – 10.63 μm)</p> <p><i>The laser beam Exits the Final lens 5 inches from the tag</i></p>
	<p><i>Never attempt to operate the Laser Tag Marker without the protective covers in place. Never attempt to override any of the safety interlocks on the tag printer. Never attempt to dismantle or repair the tag printer. In case of malfunction contact a Infosight service representative. Any of the actions mentioned above may result in permanent eye or skin damage. Refer to Laser Safety ((page 30) for more information on laser safety.</i></p>

Labels / Warnings

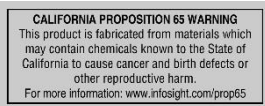
	<p>Caution, Laser Radiation – See Appendix A</p>
	<p>Warning label located on the front and top of the main cover:</p> <p>CLASS 4 INVISIBLE LASER RADIATION WHEN OPEN AVOID EYE OR SKIN EXPOSURE TO DIRECT OR SCATTERED RADIATION</p>
	<p>Warning label located above the rating plate on the back of the Laser Marker:</p> <p>CLASS 1 LASER PRODUCT</p>
<p>Environmental Conditions</p>	<p>The Labelase® Printer is intended for Indoor use only. Altitude up to 6500 feet, operating temperature 40 to 100 degrees F, 80% maximum relative humidity, rated 100-240Vac 50/60 HZ, 5 Amps, pollution degree 2</p>
<p>CAUTION</p>	<p>If this printer is not used in the manner specified by this manual, the safety features provided may be insufficient.</p>
	<p>Warning Label located on the front of the printer, near the tag feed, regarding California Proposition 65.</p>

SOFTWARE/FIRMWARE LICENSE AGREEMENT

IMPORTANT: THE SUBJECT PROGRAMS ARE LICENSED BY INFOSIGHT CORPORATION TO END-USERS FOR THEIR USE ONLY ON THE TERMS BELOW. ACCEPTING AND USING THESE PROGRAMS INDICATES YOUR ACCEPTANCE OF THESE TERMS. THIS IS A LEGAL AGREEMENT BETWEEN YOU, THE END USER, AND INFOSIGHT CORPORATION.

- 1) GRANT OF LICENSE. INFOSIGHT CORPORATION ("INFOSIGHT") agrees to grant to you a non-exclusive license to use the INFOSIGHT software/firmware program (the "PROGRAM") subject to the terms and conditions of this license agreement.
- 2) DEFINITION OF TERMS. The term SOFTWARE refers to a computer program stored on CDROM, floppy diskette, hard disk, magnetic tape, paper tape or other media, that must be loaded into the computer's memory to be executed. The term FIRMWARE refers to a computer program stored in semiconductor memory (ROM, PROM, EPROM, EEPROM, NVRAM, etc.) that is an integral part of the computer's memory. Together, these forms of computer programs are referred to as the "PROGRAM".
- 3) COPYRIGHT. The PROGRAM(s) and Documentation are owned by INFOSIGHT and are protected by United States copyright laws and international treaty provisions. The PROGRAM(s) contain trade secrets and proprietary property of INFOSIGHT. You may make one copy of the PROGRAM(s) solely for backup or archival purposes provided that the copy clearly displays the INFOSIGHT copyright notice. Additional copies may be made when authorized to do so in writing by INFOSIGHT. In addition to any other right of INFOSIGHT, INFOSIGHT has the right to terminate this license if the terms of this license are violated.
- 4) RESTRICTION ON USE AND TRANSFER. The single-processor version(s) of the PROGRAM(s) and Documentation are to be used on one computer or embedded system at any one time. The multi-processor version(s) of the PROGRAM(s) and Documentation may be used over a network provided that the number of computers accessing the network simultaneously shall not exceed the number authorized by INFOSIGHT or for which you paid the corresponding multi-processor fee. You may not distribute the PROGRAM(s) or Documentation to a third party. You may transfer the license and complete package (retaining nothing) if the transferee agrees to the terms of this License Agreement. Neither the PROGRAM(s) nor the Documentation may be changed or translated without express written permission of INFOSIGHT. You may not reverse engineer, decompile or disassemble the PROGRAM(s).
- 5) WARRANTY for the subject PROGRAM(s) is covered under the INFOSIGHT STANDARD TERMS AND CONDITIONS OF SALE.
- 6) TERM. The license is effective until terminated. It may be terminated if you fail to comply with any term or condition of this License Agreement. You may terminate this License Agreement at any time. In the event of termination, you agree to destroy the PROGRAM(s) and Documentation together with all copies and related material.
- 7) YOUR USE OF THIS PROGRAM(S) acknowledges that you have read this License Agreement and agree to its terms. This agreement is complete and supersedes any other agreement that may have related to the subject matter of this agreement.

PREFACE

The LABELASE® 1000 Tag Printer is fourth in the family of InfoSight laser tag markers. The LABELASE® 1000 series contains many new features, including: a higher internal processor clock speed, a PC-driven interface and the ability to print multilingual fonts.

This OPERATIONS manual is intended as a companion to the ONLINE REFERENCE MANUALS supplied with the Producer & Designer software package and also available on the Infosight webpage:
<http://www.infosight.com/labelaseproducer2/producer>
<http://www.infosight.com/labelaseproducer2/designer>

This OPERATIONS AND MAINTENANCE manual will be automatically installed on your computer hard drive when installing the Producer™ software. It may be found under the PROGRAMS menu with other INFOSIGHT software and HELP files.

MINIMUM SYSTEM REQUIREMENTS

- IBM PC 100% compatible computer.
- Windows 7 (32/64bit) / Windows 8/8.1 (32/64 bit)
- 1 Serial Com port, USB port, or Ethernet port (for connection to the printer).
- Color monitor (1024X768 resolution or higher recommended) .

TABLE OF CONTENTS

<i>This manual is intended for qualified service technicians only.</i>	<i>i</i>
PRINTER SETUP	1
SOFTWARE INSTALLATION	1
SYSTEM CONNECTIONS & POWER-UP:	2
PRINTER COMMUNICATIONS	2
STARTUP SEQUENCE:	3
LOADING NEW TAGS	4
PRINTING A TAG	5
LABELASE® PRODUCER™ SOFTWARE	5
PRINTER CONFIGURATION & LASER SETTINGS	7
CYCLE TIME CONSIDERATIONS	7
BASIC TROUBLE SHOOTING	9
NORMAL MAINTENANCE & SERVICING	10
AIR FILTER REMOVAL & REPLACEMENT	10
FUSE REPLACEMENT	11
LENS CLEANING PROCEDURE	12
CLEANING THE INTERNAL DRIVE MECHANISM	13
CUSTOMER SERVICE	15
FUNCTIONAL BLOCK DIAGRAM	16
Declaration of Conformity	17
Appendix A Laser Safety	19
ENGINEERING DRAWINGS	23

This page intentionally left blank.

PRINTER SETUP

The LABELASE® 1000 Tag Printer requires 100-240 VAC, 50/60 Hz, 2.4 A.

NOTE: both sides of the incoming line voltage are fused. See the Maintenance section for instructions on replacing fuses.

The LABELASE® 1000 Tag Printer should be positioned so that the power supply cord exits from the back of the machine.

The LABELASE® 1000 Tag Printer should be placed in a temperature controlled environment. This marker, though designed for industrial use, should be treated as any typical computer system and printer. Dirty environments will necessitate a more frequent cleaning schedule for internal optics.

NOTE: If the printer is housed in a secondary protective enclosure, the two exhaust fans located on the bottom of the printer directly underneath the tag feed drive area must not be obstructed. Ideally the fans should be exhausted to the environment outside the enclosure, with clean & dry makeup air entering the enclosure toward the back of the printer near the foam element air filter.

An RS-232 serial communications cable is provided for communicating with your Windows-based PC. A USB cable is also provided with the optional USB/Ethernet communications module. See the serial connector wiring diagram at the back of this manual for additional information if another serial cable is required.

SOFTWARE INSTALLATION

Before connecting the printer to your PC, LabeLase® Producer™ software should first be installed on your PC.

The easiest way to install the software is to use the Installer Disk that came with your new printer. In addition to installing the correct version of Producer™ and Designer for your specific printer model, it will also allow you to configure the appropriate communications interface.

If your original Installer Disk is not available OR for the latest release of Producer™ and Designer software, downloaded the installer package directly from <http://www.infosight.com/support/software/37-labelase-producer-metal-tag-production-software>. This is a self-contained, single self-installing file. However, it will not automatically guide you through the configuration process for communications, and you must therefore follow the steps outlined in the LabeLase® Producer™ Software Installation Manual.

The LabeLase® Producer™ Software Installation Manual is available and shipped with your equipment. The Installation Manual covers printer connection, communication connections, and installation of the software. Refer to this manual for any issues during software installation on your PC.

NOTE: LabeLase® Producer™ and Designer Software are separate executable programs, however they are bundled together and downloaded/installed together.

SYSTEM CONNECTIONS & POWER-UP:



Optional USB & Ethernet connectors. Refer to the LabelLase® Producer™ Software Installation Manual for instructions on installing required drivers.

1. Attach the included RS-232 cable from the LABELASE® 1000 Tag Printer to your Windows-based PC running LabelLase® Producer™ software.
2. Connect the AC power cord to the printer and plug the other end into a nearby power receptacle. **NOTE: both sides of the incoming line voltage are fused. See the Maintenance section for instructions on replacing fuses.**
3. Place the security key into rear of machine. The key functions as an ON-OFF switch.
4. Turn key to the vertical (ON) position. **NOTE:** The security key can only be removed when in the OFF position.
5. Press the power switch to the ON position (1).

NOTE: rear panel layouts may vary, depending on the printer configuration

PRINTER COMMUNICATIONS

LL1000 series of printers requires a communication link to a PC running Producer™ software. In addition to the standard serial RS232 link, an optional integrated USB/Ethernet module is available. The LabelLase® Producer™ Software Installation Manual addresses Printer Communications in Sections “Connection Type”, “RS232 Serial COM Port”, “USB Port”, and “Ethernet Network Connection”.

STARTUP SEQUENCE:

1. Install tag stock onto tag payoff reel. Be sure to re-attach the keeper bar to prevent the tag roll from falling off the reel.
2. Confirm that the rear power switch is ON and the rear key switch is in the vertical ON position.
3. Remove E-STOP by twisting the red button on the top of the printer by one-quarter turn clockwise.
4. Feed tag stock into printer. If necessary, press the tag FEED button to align tags to the breakoff location.
5. Start LabeLase® Producer™ software on your PC.
6. Load a pre-existing tag layout, or design a new tag layout. NOTE: designing or changing a tag layout requires SUPERVISOR login and using LabeLase® Designer Software.
 - A. Refer to the LabeLase® Producer™ Software Manual for loading a tag layout.
 - B. Refer to the LabeLase® Producer™ Software Manual and Designer Software Manual for changing and/or designing a tag layout.
7. Adjust printer setup parameters if necessary (e.g., laser speed). NOTE: other than setting laser speed (LIGHTER/DARKER slider bar), this feature requires SUPERVISOR login.

NOTE: The Producer™ software is password protected for all features beyond loading an existing tag layout, entering tag variable data, adjusting laser speed and initiating printing.

The default password for new installations is blank (no data, no spaces). A new password should be created before printer is commissioned for regular operator use.

LOADING NEW TAGS

CAUTION: DO NOT GRIP THE TAG STOCK BY ITS EDGES WHEN FEEDING INTO THE PRINTER. PROTECT YOUR HANDS AND FINGERS FROM THE SHARP EDGES OF THIN METAL TAG STOCK AT ALL TIMES.

Loading a new roll of tags is as easy as mounting the new roll on the payoff reel so that it unwinds from the bottom, and hand-feeding the leading edge of the tag stock into the rear feed slot. The marking side of the tag stock should be facing UP. Gently push it into the slot until it stops against the internal (rear drive) roller. The printer will then automatically draw the tag stock into the printer.

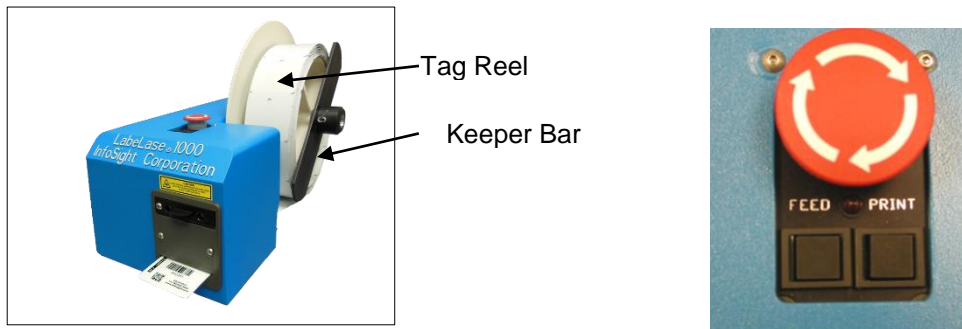

Reminder - The marker is not ready for use and will not feed tags until the E-STOP button is returned to the OUT position by twisting the red button one-quarter turn CLOCKWISE.

If necessary, tag stock can be manually fed into the printer by pressing the FEED button located beside the large red E-STOP button.

Feed Button Operation:

Press & Release Quickly = feed one tag-length OUT (forward).

Press & Hold for 1 Second = feed one tag-length IN (reverse).

Press & Hold for longer than 2 Seconds = CONTINUOUS REVERSE FEED.

PRINTING A TAG

Note - The following assumes the LABELASE® 1000 Tag Printer has already been setup with a tag layout.

There are several ways to print a tag using the LABELASE® 1000.

- A) If tag stock is loaded in the machine from the rear payoff reel and properly aligned at the break off exit point:
1. Pressing the **PRINT button** located beside the red E-STOP will initiate printing of 1 or more tags, depending on operator-entered data on the main Producer™ screen.
 2. Pressing the **F12 key** on your PC.
 3. Placing the mouse pointer over the **Begin Print** button on your PC and left clicking.
 4. A **print command** may be sent from your host computer to your PC via Extended Protocol.
- B) If there is no tag stock feeding in from the back of the machine, a single tag inserted in the FRONT slot will be automatically drawn into the printer.
5. If the AUTO PRINT SINGLE ITEMS box is checked (enabled) in the SETUP / PRINTER CONFIGURATION menu (requires supervisor login), then **tag printing will begin automatically** with no further action or input required.
 6. If the auto print box is NOT checked, then any of the above methods in paragraph (A) may be used to initiate printing.

CAUTION: DO NOT GRIP THE TAG STOCK BY ITS EDGES WHEN FEEDING INTO THE PRINTER. PROTECT YOUR HANDS AND FINGERS FROM THE SHARP EDGES OF THIN METAL TAG STOCK AT ALL TIMES.

NOTE: The SINGLE PRINT feature of the printer requires a minimum tag or tag-strip length of three inches (76mm).

For example, a single 3x3 (or 3x4, 3x6, etc.) tag may be printed. If single printing of a 1x3 (25 x 76mm) tag is desired, a strip of at least 3 tags must be inserted in the front slot.

LABELASE® PRODUCER™ SOFTWARE

LabeLase® Producer™ is an integrated, Windows-based application for complete control of tag design and printing. For complete details, please refer to the ONLINE REFERENCE MANUAL supplied with the software, or on the web at <http://www.infosight.com/labelaseproducer2/producer>.

Features:

The software has many features designed to provide maximum flexibility to serve the customer's specific marking needs. Some of these features include:

- ❑ Built-in and online (web access) HELP.
- ❑ Total freedom to change tag layout whenever needed.
- ❑ WYSIWYG (“What You See Is What You Get”) user interface for simple and intuitive tag design.
- ❑ New features emulating popular presentation software packages to speed layout and organization of complex designs containing multiple text and graphics fields.
- ❑ An unlimited number of data, text, barcode and graphics fields.
- ❑ Move fields easily with drag-and-drop.
- ❑ Rotate fields in 90-degree increments.
- ❑ Unlimited UNDO-REDO to easily correct mistakes.
- ❑ Optional placement grid with snap-to placement aid.
- ❑ Optional field anchor display shows field alignment.
- ❑ Zoom in/out for detailed display.
- ❑ Tag geometry features such as holes, slots, bare edges and bend lines can be shown.
- ❑ Prints all PC-installed fonts, including multi-byte characters for Asian languages.
- ❑ User-selectable download of message data from a host computer via RS-232, network TCP/IP, or network file transfer. A wide selection of communications protocols includes InfoSight Extended, emulation of Zebra and Intermec standard printers, and simple comma or tab-separated, flat-file formats.
- ❑ Operator entry of message data, for example if the host computer is unavailable.
- ❑ Easy control over printer setup parameters such as laser speed and high/low pixel density (i.e., “draft” and “normal” printing modes)
- ❑ Auto-print feature for single tag printing (i.e., whenever a roll of tags is not loaded, a single tag can be auto-printed simply by inserting the tag in the front tag slot).
- ❑ Auto-incrementing of all text and number fields, for unattended batch printing.
- ❑ Option to make text and graphic fields “non-printable”
- ❑ Option to make non-printable fields visible in the File Open dialog, and on the Producer™ main screen.

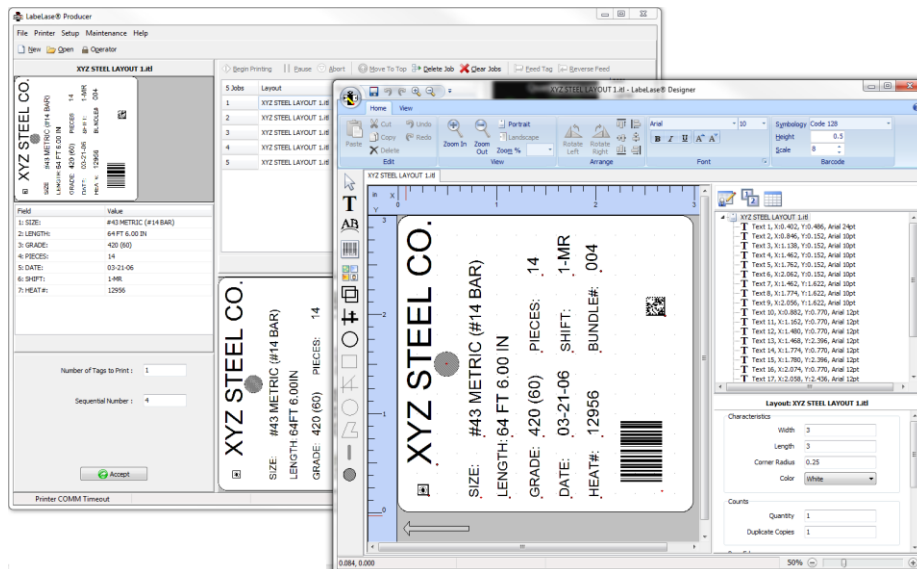

PRINTER CONFIGURATION & LASER SETTINGS

The LabeLase® 1000 printer and LabeLase® Producer™ software are designed with a high degree of flexibility and user-control, to enable the system to be used in a wide range of applications and on an ever-increasing array of laser-markable materials.

Calibration and configuration settings are accessed in LabeLase® Producer™ under SETUP-PRINTER CONFIGURATION. On-line help instructions will guide you through each of the available settings. The most common parameters for fine-tuning the performance of the printer beyond the easy-to-use LIGHTER/DARKER SLIDER BAR are LASER SPEED, LASER OFF TICKLE, and LASER ON DUTY CYCLE, all of which are found under the LASER tab. Each of these parameters separately and together can be adjusted to create the right balance of black/white contrast, fineness of detail and cycle time.

As laser speed is increased printing cycle time will be faster. In general, as laser speed increases, duty cycle must also be increased to achieve the same relative blackness. Some materials with especially sensitive surfaces, such as PermaLabel®, will print more consistently at lower duty cycles, and therefore correspondingly lower laser speeds. Tickle controls the readiness of the laser to fire and helps maintain consistency of marking across the tag surface. Some tag materials are more sensitive to power variation than others, but in most cases this parameter can be left at its factory setting.

Typical Range of Settings (DRAFT mode OFF):

- Laser Speed: 50-75 ips
- Laser Off Tickle: 7-15 μ s
- Laser On Duty Cycle: 60-95%

Each printer is calibrated in our factory before shipping, and the results are recorded on two tags as shown at the right. Save these tags in the event you ever want to return the printer to its original factory configuration.

Experience has shown the following settings to be a good starting point for the most common types of tag material. Each individual application may then be fine-tuned to achieve the right balance of cycle time, fineness of detail, and black/white contrast.



Calibration Tag

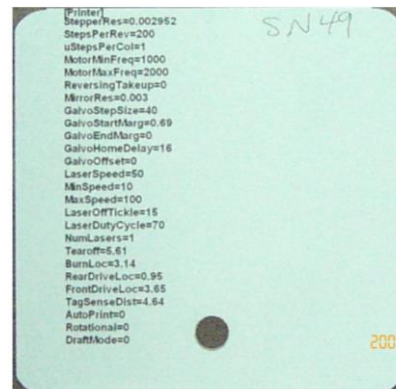

Factory Settings

Typical Laser Settings (DRAFT mode OFF)

	InfoTag® Hi - Temp	Pic-Anneal®	PermaLabel®	X-Tag™
Laser Speed	70	60	55	20
Tickle	15	15	15	15
Duty Cycle	95%	95%	95%	95%

CYCLE TIME CONSIDERATIONS

Tag layout and printer configuration can have a significant influence on cycle time. Here are a few techniques that in many cases can significantly speed printing.

1. Select DRAFT mode. When DRAFT mode is on, stepper and mirror resolution, laser speed, font sizes, and barcode and graphic scales are automatically adjusted.

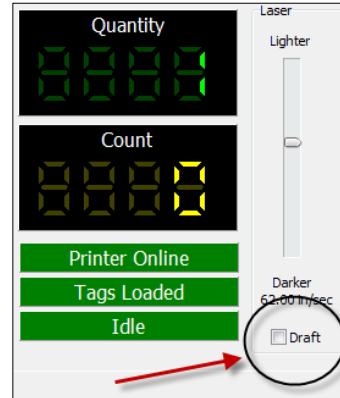

2. Increase laser speed (move slider bar to LIGHTER). It may be necessary to increase Laser Duty Cycle to maintain black/white contrast.

3. Use ARIAL BLACK font for text, to create darker easier-to-read characters. Also try using the BOLD font setting instead of a larger font size.

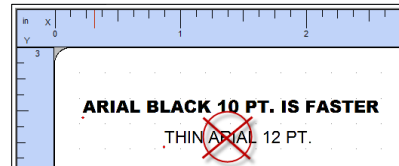

4. Design printing to run ACROSS the tag at 90° rotation (right angles to tag feed) rather than down the tag at 0° rotation (printing parallel to tag feed is slower).

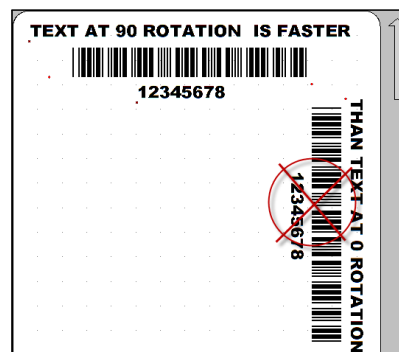

5. Avoid drawing graphic boxes around text or other graphics with long vertical (parallel to tag feed) lines.

6. Combine text strings into fewer lines. A single long line of text is more efficient than several short lines of text (at 90° rotation, parallel to tag feed).

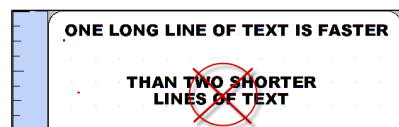

7. Keep graphics/logo X-scale and Y-scale factors equal to 1. If the graphic or logo must be re-sized to fit on the tag, use an external application such as MS PAINT to change the dimensions of the image and re-save the BMP file before importing into Producer™.

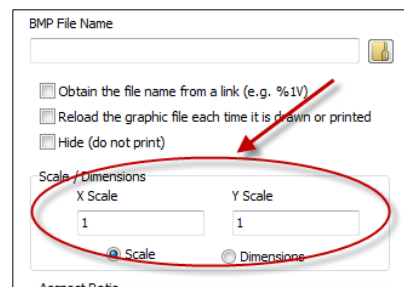

BASIC TROUBLE SHOOTING

Service during normal business hours (Monday-Friday, 8am-5pm):

1.888.642.3600 (outside the USA call +1.740.642.3600)

Emergency after-hours service:

1.800.401.0716 (outside the USA call +1.740.642.4666)

Red LED Status Light:

- STEADY ON: ready to print.
- OFF: no power to laser (power cord, key switch, power switch, fuses).
- SLOW BLINK: out of tag stock.
- FAST BLINK: E-STOP.

Problem: Marker does not respond to print button.

- Check power cord.
- Check key switch.
- Check E-STOP.
- Check tag stock.
- Check serial cable to PC.
- Producer™ software must be running on the connected PC.
- Bottom of main Producer™ screen indicates printer status – “ONLINE”, “ESTOP” or “UNKNOWN MODE”. If UNKNOWN MODE, check communications cable and settings.
- From within Producer™, click on HELP-ABOUT. If the FIRMWARE VERSION is blank, your PC does not see the printer. Check communications cable and settings.

Problem: Out of tag message on PC screen.

- Load more tag stock into printer.
- Insert single tag in front tag slot.

Problem: Tag exiting too far or not far enough (breakoff “nick” not aligned with exit slot).

- The printer stepper motor may need to be re-calibrated. This is available under the Maintenance Menu of the Producer™ Software. The Producer™ Software Manual outlines this process in the Maintenance/Calibrate Motor Section beginning on page 44.

Problem: Tag print appears very light, fine lines appear to drop out.

- Reduce laser speed (DARKER)
- Increase Laser Off Tickle (SETUP-PRINTER CONFIGURATION).
- Final output lens may require cleaning (see Maintenance section below).

Problem: Tag print shows “shadows”

- Decrease Laser Off Tickle (SETUP-PRINTER CONFIGURATION).

Problem: Tag print not aligned correctly with breakoff “nicks” (leading & trailing edges).

- Check that actual tag size in machine and programmed tag size in Producer™ (LAYOUT-SETUP-GEOMETRY) are the same.
- The printer stepper motor may need to be re-calibrated. This is available under the Maintenance Menu of the Producer™ Software. The Producer™ Software Manual outlines this process in the Maintenance/Calibrate Motor Section beginning on page 44.

Problem: Barcode too long for tag size.

- Reduce number of characters in barcode data.
- Use more efficient barcode symbology.
- Reduce barcode scale.

NORMAL MAINTENANCE & SERVICING

Regular maintenance that can be performed by the operator includes only cleaning and/or replacing the rear air filter. That process is described below.

Fuse replacement may be required at times. The process for that is below.

A qualified service technician is required to perform additional maintenance. Periodic cleaning of both surfaces of the final pass-through lens to remove dust is necessary. Additional cleaning or maintenance requires the removal of the laser cover. Specific training is required for this maintenance.

AIR FILTER REMOVAL & REPLACEMENT

The LabeLase® 1000 Tag Printer includes a light-duty foam filter element, intended for use in a normal office environment. It is not intended to protect the printer from industrial contaminants or vapors, typical of a factory or mill environment.

As the filter element accumulates dust and pollen over time, air flow through the printer may be reduced. This may cause excessive dust to accumulate on the internal optics (lenses and mirrors), which may shorten their life considerably. Therefore, it is important to monitor the condition of the filter and determine the appropriate cleaning frequency for your specific environment.

At high duty cycles when printing large batches of tags with a high percentage of black (printed) area, reduced air flow may also cause the internal temperature sensor to automatically shut down the laser tube until it cools back to its normal operating temperature – this is normal.

The filter cover is located on the rear of the printer, and is held in place by two thumb screws.

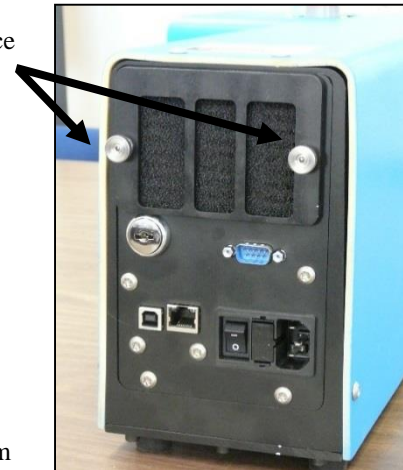

Loosen the thumb screws and carefully remove the cover and the foam filter element underneath.

Carefully blow any lint or dust off the filter, or gently wash it in soap and water. Dry the filter thoroughly before reinstalling.



FUSE REPLACEMENT

The incoming AC line is fused on both legs. Before replacing the fuses, first determine and fix the cause of the blown fuses.

CAUTION: BE SURE TO REMOVE THE AC POWER CORD BEFORE REMOVING THE FUSE HOLDER OR PERFORMING ANY OTHER TROUBLESHOOTING OR MAINTENANCE !

To replace the fuses, remove the fuse holder on the back of the printer between the power cord input and the on-off rocker switch. The fuse hold only goes back in one-way. If it does not fit easily, turn it upside down and then insert it gently so that it snaps in place.

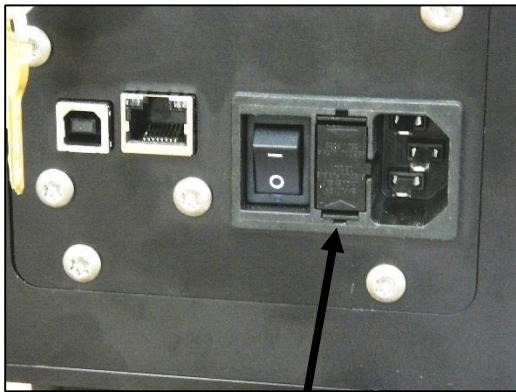

FUSE HOLDER

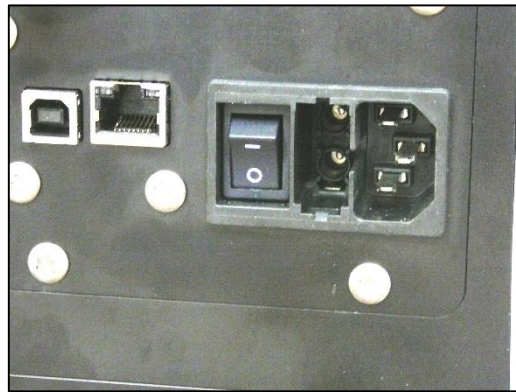

FUSE HOLDER REMOVED



FUSES ARE RATED FOR 250V / 5A AC

LENS CLEANING PROCEDURE

CAUTION: LASER OPTICS ALIGNMENT SHOULD ONLY BE PERFORMED BY A QUALIFIED TECHNICIAN.

The lens slide is secured with a SECURITY TORX screw to prevent unintended opening.



After removing the security screw, carefully open the slide to expose the lens.

Carefully perform the cleaning procedure described below, then re-insert the lens slide and secure it with the security screw.



CAUTION: DO NOT TOUCH LENS WITH FINGERS OR ANY SUBSTANCE CONTAINING ALCOHOL, OR PERMANENT DAMAGE MAY RESULT.

LENS CLEANING PROCEDURE:

- Use a cloth that will not leave any fibers and is not abrasive.
- White vinegar is recommended. **DO NOT USE ALCOHOL!!**
- Gently wipe the moistened cloth across the lens so that the liquid evaporates behind the cloth, avoiding streaks.
- DO NOT RUB HARD!**
- DO NOT USE COMPRESSED AIR TO CLEAN OPTICS!**
- DO NOT USE EYE GLASS WIPES CONTAINING ALCOHOL!**
- For optics that are severely contaminated or damaged, contact InfoSight for replacement.

CLEANING THE INTERNAL DRIVE MECHANISM

In some environments with excessive ambient dust, limited airflow through the printer and high rates of operation, dust and debris may collect in the drive mechanism area of the printer. Over time this dust and debris may block the laser beam and/or affect the operation of internal sensors and drive rollers.

CAUTION: ALWAYS UNPLUG BOTH THE PRINTER POWER CORD AND ALL COMMUNICATION CABLES BEFORE SERVICING THE DRIVE UNIT.

The front cleanout plate may be removed to clean the drive mechanism without removing the printer cover. Extreme care must be used to avoid damaging laser optics, pass-through lens, optical tag & notch sensors, and other delicate components. The pass-through lens should be left in place to avoid introducing dust into the laser optics.

A soft brush or long Q-Tip can be used to loosen any debris, and a small PC keyboard vacuum with a 90-degree or flexible nose piece can be used to remove the loosened debris.

The front cleanout plate is secured with two SECURITY TORX screws to prevent unintended opening

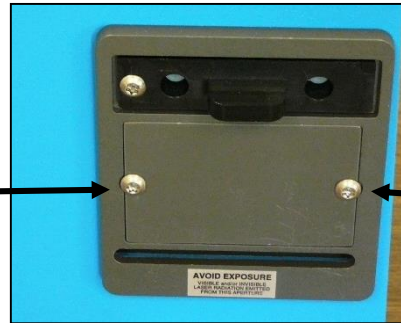

REAR NOTCH SENSOR

FRONT TAG SENSOR

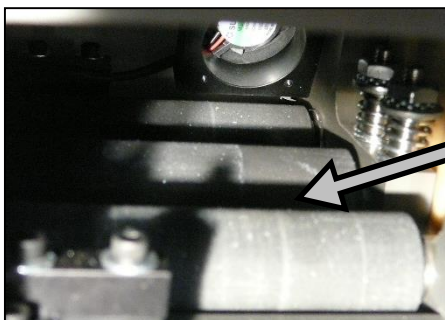

Laser Beam hits the tag between Front and Middle drive rollers. Dust may collect at the extreme left and right-hand sides of this area.

CAUTION: ALWAYS REPLACE THE FRONT CLEANOUT PLATE BEFORE CONNECTING POWER AND OPERATING THE PRINTER.

NEVER OPERATE THE PRINTER WITH THE FRONT CLEANOUT PLATE OR THE PASS-THROUGH LENS REMOVED !!

This page intentionally left blank.

CUSTOMER SERVICE

How to reach customer service:

Phone Support	InfoSight Corporation Customer Service offers free phone support to answer questions during normal non-holiday working hours, Monday through Friday 8am to 5pm Eastern time (New York, USA). Call +1.888.642.3600, or outside the USA call +1.740.642.3600.
Emergency Service	After regular business hours, call: +1.800.401.0716 (USA or Canada) or +1.740.642.4666 (International).
On-Site Service	InfoSight Corporation can dispatch a Field Service Engineer to your facility to perform equipment start-up, repair, maintenance, and training.
Service Contracts	Periodic scheduled on-site maintenance, technical service and extended warranties can be arranged by contacting Customer Service at the number below.
Factory Service	Call Customer Service for a Return Authorization Number before returning equipment to our factory for repair and/or major maintenance.

For more information regarding any of these services, call +1.888.642.3600 (outside the USA call +1.740.642.3600) and ask for Customer Service.

Or, visit us on the worldwide web at www.infosight.com

FUNCTIONAL BLOCK DIAGRAM

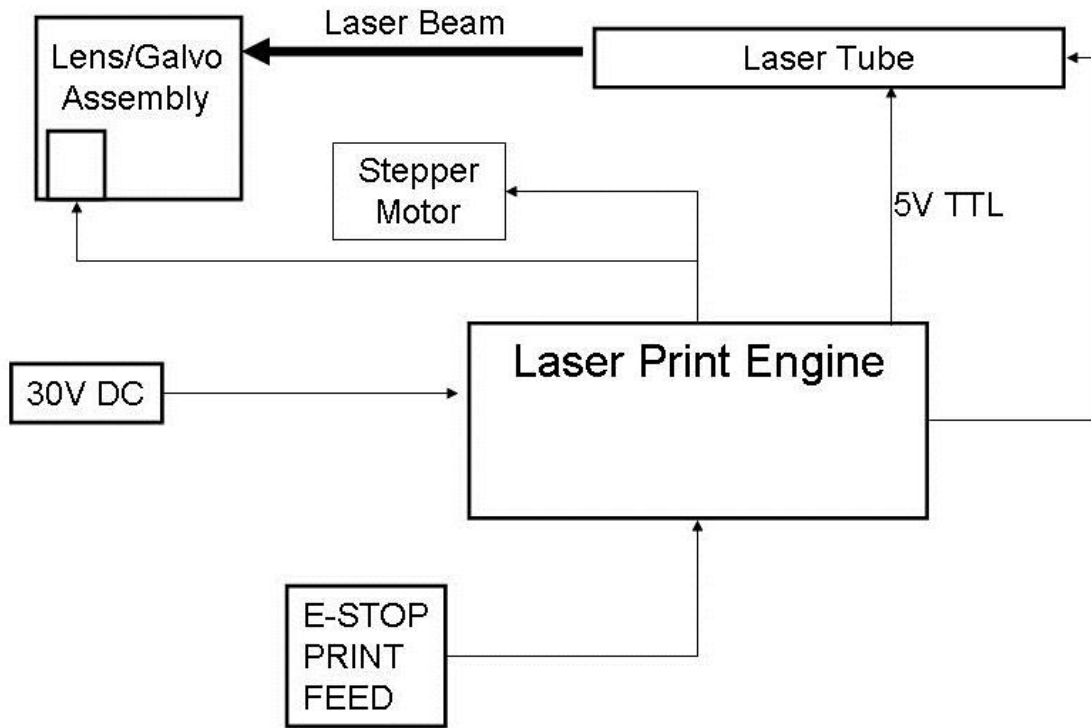

LabelLase® 1000 Serial port connection to an IBM-PC or equivalent.

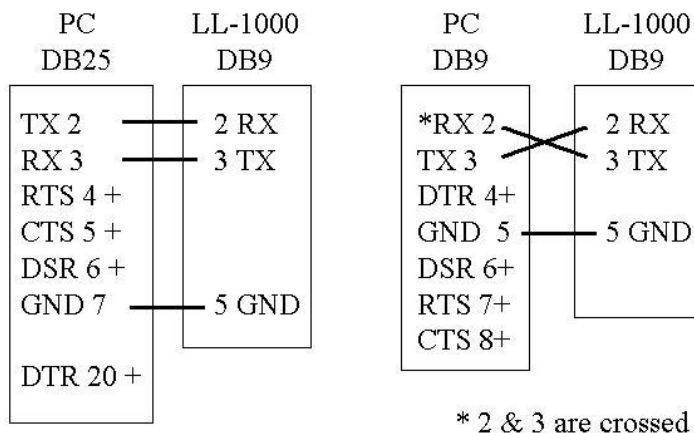

Note: Handshake protocol is XON / XOFF. Communications adapters such as USB to RS232 must support XON / XOFF.

XON is DC1 CTL-Q or 11h or 17 decimal
 XOFF is DC3 CTL-S or 13h or 19 decimal

Declaration of Conformity

InfoSight Corporation

20700 US Highway 23 Chillicothe, Ohio 45601
+1-740-642-3600 TEL +1-740-642-5001 FAX

InfoSight hereby declares the equipment specified conforms to the Classification(s), Directive(s) and Standard(s) set forth in this document.

InfoSight produces laser systems within one of two classes as identified and classified by the CDRH. These are Class I and Class IV. (see CDRH 21 CFR (J) 1040.1 - 1040.5). End user of the equipment should be familiar with ANSI, CDRH and OSHA standards for radiation emitting devices as they apply to them also.

ANSI Z136.1 - 1993

We will provide adequate data to the LSO (Laser Safety Officer) enabling LSO to designate NHZ (nominal hazard zone) as required pursuant to Class IV 3.4.1

CDRH 21 CFR (J) 1040.1 1040.5

OSHA Publication 8-1.7 Section II Chapter 6

Certifications:

EMC Emissions

EN 55022:1994/A1:1995/A2:1997 Class A ITE emissions requirements (EU)

FCC 47 CRF Part 15 Class A emissions requirements (USA)

EMC Immunity:

EN 50082-2:1995 EMC heavy industrial generic immunity standard

Note: InfoSight design guidelines are drawn from ANSI and CDRH



1.1.1 LL1000 Declaration of Conformity

Declaration of conformity

Konformitätserklärung

Déclaration de conformité

Declaración de Conformidad

Verklaring de overeenstemming

Dichiarazione di conformità

We/Wir/ Nous/WIJ/Noi: **Infosight Corporation**

20700 US Rt 23

Chillicothe, Ohio 45601 USA

declare under our sole responsibility that the product,
erklären, in alleiniger Verantwortung, daß dieses Produkt,
déclarons sous notre seule responsabilité que le produit,
declaramos, bajo nuestra sola responsabilidad, que el producto,
verklaren onder onze verantwoordelijkheid, dat het product,
dichiariamo sotto nostra unica responsabilità, che il prodotto,

LL1000

to which this declaration relates is in conformity with the following standard(s) or other normative documents.
auf das sich diese Erklärung bezieht, mit der/den folgenden Norm(en) oder Richtlinie(n) übereinstimmt.
auquel se réfère cette déclaration est conforme à la (aux) norme(s) ou au(x) document(s) normatif(s).
al que se refiere esta declaración es conforme a la(s) norma(s) u otro(s) documento(s) normativo(s).
waarnaar deze verklaring verwijst, aan de volende norm(en) of richtlijn(en) beantwoordt.
a cui si riferisce questa dichiarazione è conforme alla/e seguente/i norma/o documento/i normativo/i.

EMC Emissions:

- EN 55022:1998/A1:2000/A2:2003 Class A ITE emissions requirements (EU)
- FCC 47 CFR Part 15 Class A emissions requirements (USA)

EMC Immunity:

- EN 55024:1998/A1:2001/A2:2003 ITE - immunity characteristics

1.2 TEST DATES

November 18, 22-24, 29, 30, December 1, 8, and 9, 2004

Edward S. ONeal

2/25/2005

Chillicothe, Ohio

APPENDIX A | LASER SAFETY

LASER SAFETY

04/23/03

Section I: Introduction to Laser Safety

Lasers, like arc welders, are sources of intense light that require certain precautions to insure a safe, comfortable and compliant working environment. This is especially true since the laser included in this marking equipment operates in the infrared (invisible) portion of the light spectrum. The enclosure surrounding the marking area is designed to prevent human exposure to the light emitted by the laser. The following information covers the procedures taken to design a safe, efficient environment for laser marking equipment.

Laser products are categorized into one of four classes based upon the power of the laser light that is accessible to any person during normal operation. These classes range from Class 1, the lowest class requiring no additional safeguards other than those provided by the manufacturer, to Class 4, the highest class that requires additional operator and working environment safeguards for safe operation.

Class 1 laser marking systems include enclosures integral to the workstation that are constructed to prevent human access to the laser beam. Class 1 systems are safe in all working environments; they are installed and operated as any other industrial machine tool. Class 1 laser systems do not require the use of any special laser safety equipment by operators or bystanders during their normal operation.

Class 4 laser marking systems do not incorporate protective enclosures. Extra precautions are required.

The LabeLase®1000 Tag Printer complies with Class 1 during normal use because of the numerous interlocks provided as detailed in section II.

During service and/or alignment the LabeLase 1000 Tag Printer becomes a Class 4 device. Servicing should be performed only by a **Qualified Laser Service/Safety Technician!** Because of the Class 4 classification, InfoSight will provide such a person to be available to the end user of this marker.

The nominal power output of the laser used is 10 watts, with a maximum peak power output of 30 watts. It is a CO2 infrared (invisible) laser with a wavelength of 10.57 to 10.63 microns. The Radiant energy and the wavelength are less than Class 1 requirements during normal operation.

Section II: Types of safety interlocks.

There are several types of safety features provided on the InfoSight LabeLase 1000 Tag Printer:

Type 1 includes **mechanical switches**. These switches are located atop the marker and on the rear of the marker. These switches remove power supplied to the laser marker, as shown in electrical drawings.

- Switch A -- Large Red, easily accessible, E-STOP operator Emergency Stop Push Button.
- Switch B -- Key switch
- Switch C -- On/Off rocker switch

Type 2 includes **optical sensors**. Sensors monitor whether tag material is in place and the marker is able to move the tag material. These two sensors are monitored by the marking microprocessor.

Type 3 includes **mechanical design**. Here, narrow slots are provided to minimize the release of laser radiation. The beam path from laser tube to final pass through lens is entirely enclosed in a metal shield, with suitable material that will absorb the heat produced by the beam emitting from the CO2 laser.

Type 4 includes **Password Security access**. The Software requires a **supervisor password** to change layout of tags or to alter the operating parameters of the marker itself.

The features and precautions described above are designed with the safety of the user in mind. Should you have any questions or suggestions please contact InfoSight directly.

LASER HAZARD CLASSIFICATIONS

The intent of laser hazard classification is to provide clear distinction of the lasers' properties and hazards to users so appropriate protective measures can be taken. Classification is based on the maximum output available for the intended use. Specific labeling requirements indicate that the class of the laser as well as the emission wavelength(s) and any other applicable precautionary instructions must be included on any signage. Laser classification is also used for determining requirements for medical surveillance for those individuals working with and around lasers.

The Federal United States laser safety standard [21 CFR 1040.10], the ANSI standard [ANSI Z136.1], as well as the international standard [EN 60825], divide lasers into five distinct hazard categories. These classes are based upon the combination of wavelength range, power, and emission duration, which are used to determine the level of risk and the potential to cause biological damage to the eye or skin. The definitions compiled from ANSI Z136.1 are as follows:

Class 1: Any laser, or laser system containing a laser, with wavelength ranges from Ultraviolet through Far Infrared (180 nm – 100,000 nm +), that cannot emit laser radiation levels exceeding Class 1 Accessible Emission Limits (AEL) as defined by ANSI Z136.1. For example this would compute to exposure (for an eight-hour period) for a 488 nm laser of no greater than 0.2 mW. Basically, the laser radiation level emitted by a device classified as Class 1 produces no hazard whatsoever to the user during normal operation. Presently, Class 1 lasers and laser systems are exempt from all control measures. The Class 1 designation does not apply during times of maintenance or service where the safety controls of the device are defeated or otherwise removed. The Class 1 environment resumes once the device is returned to its original state with all safety devices properly reconnected.

Class 2: This classification applies only to continuous wave (CW) and repetitive-pulse lasers and laser systems of the visible part of the electromagnetic spectrum (400 – 700 nm) that exceed Class 1 levels, but do not exceed an average radiant power of 1 mW.

Class 3a: Lasers and laser systems that have an accessible output between one and five times the Class 1 AEL for wavelengths shorter than 400 nm or longer than 700 nm, or less than five times the Class 2 AEL for wavelengths between 400 and 700 nm. Lasers of this class have intermediate power ranges of 1 - 5 mW.

Class 3b: Lasers and laser systems having the power range between 5 - 500 mW. This applies to lasers with wavelength ranges from Ultraviolet through Far Infrared (180 nm – 100,000 nm +). These lasers or laser systems can produce a hazard if viewed directly, and may produce an eye hazard when viewing diffuse reflections off of a shiny surface at angles of less than 5 degrees from the source, however Class 3b lasers should not produce a hazardous diffuse reflection from a matte (not shiny) surface.

Class 4: Lasers and laser systems having power greater than 500 mW. This applies to lasers with wavelength ranges from Ultraviolet through Far Infrared (180 nm – 100,000 nm +). This class of laser poses the greatest hazard, and any and all precautions should be taken to protect oneself from exposure to direct or diffuse laser radiation. Direct exposure to the eye from this class of laser can cause permanent damage. Stray beams are potential fire hazards and combustible material should be kept out of beam paths at all times.

1.3 CONTROL MEASURES FOR LASER CLASSIFICATIONS

Control Measure	Class 1	Class 2	Class 3a	Class 3b	Class 4
Activation Warning Systems	No requirement.	No requirement.	No requirement.	Should have.	Shall have.

<i>Indoor Laser XE Optics Lasers Controlled Area</i>	<i>No requirement.</i>	<i>No requirement.</i>	<i>No requirement.</i>	<i>Shall have. Nominal Hazard Zone analysis required.</i>	<i>Shall have. Nominal Hazard Zone analysis required.</i>
<i>Labels</i>	<i>Shall have</i>	<i>Shall have</i>	<i>Shall have.</i>	<i>Shall have.</i>	<i>Shall have.</i>
<i>Area Posting</i>	<i>No requirement.</i>	<i>No requirement.</i>	<i>Should have</i>	<i>Shall have. Nominal Hazard Zone analysis required.</i>	<i>Shall have. Nominal Hazard Zone analysis required.</i>
<i>Standard Operating Procedures</i>	<i>No requirement.</i>	<i>No requirement.</i>	<i>No requirement.</i>	<i>Should have.</i>	<i>Shall have.</i>
<i>Education and Training</i>	<i>No requirement.</i>	<i>Should have.</i>	<i>Should have.</i>	<i>Shall have.</i>	<i>Shall have.</i>
<i>Authorized Personnel</i>	<i>No requirement.</i>	<i>No requirement.</i>	<i>No requirement.</i>	<i>Shall have.</i>	<i>Shall have.</i>
<i>Warning Signs and Labels</i>	<i>No requirement</i>	<i>Should have.</i>	<i>Should have.</i>	<i>Shall have. Nominal Hazard Zone analysis required.</i>	<i>Shall have. Nominal Hazard Zone analysis required.</i>

ANSI Z136.1 requires specific control measures for each laser classification and the environment in which they are used. The chart above lists some of the requirements that may need to be implemented in a laboratory setting. The company Laser Safety Officer, or designee, should reference the applicable safety regulations for appropriate control measures to implement in the area the marker will be used.

1.4 BIOLOGICAL EFFECTS OF LASER IRRADIATION

1.4.1 Eye Injury

Because of the high degree of beam collimation, a laser serves as an almost ideal point source of intense light. A laser beam of sufficient power can theoretically produce retinal intensities at magnitudes that are greater than conventional light sources, and even larger than those produced when directly viewing the sun. Eye exposure to a direct beam can cause permanent eye damage including blindness. Protective eyewear should always be worn when potential exposure to direct laser beams exist.

- Due to the lens-like focusing effect of the human eye, it is 100,000 times more vulnerable to injury than the skin.
- Laser safety eyewear should always be available for the wavelengths of lasers in use.
- Eye protective equipment, however, should be considered the last line of defense against laser beam exposure – engineering and administrative controls should be used first.
- Remove all jewelry when working with an open beam to prevent reflection of the beam in unsafe directions.
- When possible, use all protective housings, interlocks and shields.
- Laser Safety Eyewear should always be worn during laser repair, alignment, or installation, or at any time when any laser safety control is not in place.

1.4.2 Thermal Injury

The most common cause of laser-induced tissue damage is thermal in nature, where the tissue proteins are denatured due to the temperature rise following absorption of laser energy.

The thermal damage process (resulting in burns) is generally associated with lasers operating at exposure times greater than 10 microseconds and in the wavelength region from the near ultraviolet to the far infrared. Tissue damage may also be caused by thermally induced acoustic waves following exposures to sub-microsecond laser exposures.

1.4.3 Skin Injury

To the skin, UVA (315-400 nm) can cause hyperpigmentation and erythema (aka: sunburn). Exposure in the UVB (280-315 nm) range is most injurious to skin. In addition to thermal injury caused by ultraviolet energy, there is also possibility

of radiation carcinogenesis from UVB. The shorter wavelengths are absorbed in the outer dead layers of the epidermis (stratum corneum) and the longer wavelengths have an initial pigment-darkening effect followed by erythema if there is exposure to excessive levels.

The hazards associated with skin exposure are of less importance than eye hazards; however, with the expanding use of higher-power laser systems, particularly ultraviolet lasers, the unprotected skin of personnel may be exposed to extremely hazardous levels of the beam power if used in an unenclosed system design.

Skin burns caused by lasers can happen quite fast and with great intensity. Protective clothing should be worn when potential exposure to direct laser beams exist.

- UVC: 200-280 nm exposure may cause erythema (sunburn), skin cancer, and burns.
- UVB: 280-315 nm exposure may cause accelerated skin aging, increased skin pigmentation and burns.
- UVA: 315-400 nm exposure may cause pigment darkening and skin burns.
- Visible: 400-700 nm exposure may cause photosensitive reactions and skin burns.
- Infrared 700-100,000 nm exposure may cause skin burns.

ENGINEERING DRAWINGS

DRAWING ITM19695 – LABELASE 1000 COVER ASSEMBLY

DRAWING ITM19696 – LABELASE 1000 DRIVE ASSEMBLY

DRAWING ITM24439 – LABELASE 1000 OPTICS ASSEMBLY

DRAWING ITM23138 – LABELASE 1000 BASE ASSEMBLY

**DRAWING ITM19870 – LABELASE 1000 SPOOL, PAYOFF GENERAL
ASSEMBLY**

**DRAWING ITM19953 – LABELASE 1000 LASER TAG PRINTER WIRING
DIAGRAM**